











AS 1428.1
Compliant

TOUCH-FREE TAPWARE

FOR COMMERCIAL & PUBLIC BATHROOMS (Wall Mounted)

-  Intelligent Sensor for fast & reliable handwashing
-  Hygienic
-  Saves water
-  Low Maintenance
-  Auto shut-off after 1 minute
-  Durable commercial grade construction
-  AC mains power and/or 4x AA Battery (lasts 6+ months)
-  Inlet pressure range 50kpa - 500kpa
-  Maximum water temperature 80°C



WaterMark
AS/NZS 3718:2005
WM-032166



SF1113PC

BRONTE





Touch-free Tapware
SF1113PC - Bronte
 Also available in:

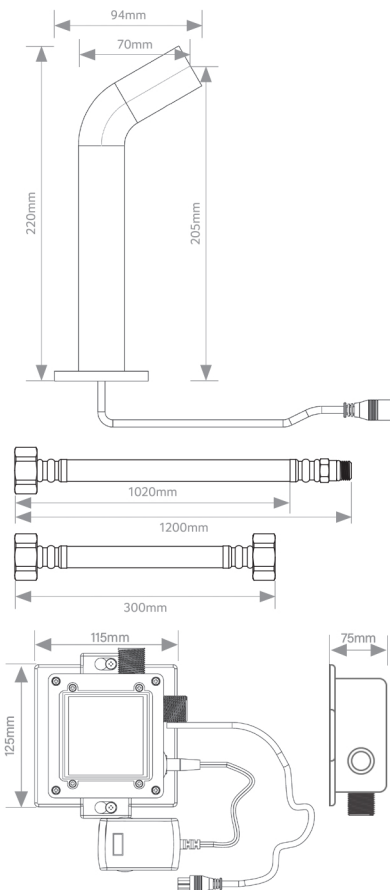
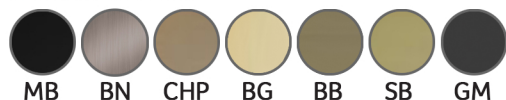

WELS Rating	6 Star, 5.5L per minute
Max Operating Temperature	80° C
Water Supply Temperature	Suitable for cold or warm water supply (with thermostatic mixing valve)
Operation	Auto focus infrared sensor
Recommended working pressure	50-500 kPa - Note: New Regulation: 500 kPa maximum static pressure at any outlet within a building. (Ref. AS/NZS 3500.1)
Finish	Polished Chrome (PC), Matt Black (MB), Brushed Nickel (BN), Champagne (CHP), Brushed Gold (BG), Brushed Brass (BB), Satin Brass (SB), Gunmetal (GM)
Power Supply	DC Battery box (4x AA) or 240V mains supply AC adapter (included)
Sensor Detection	≤1 seconds
Valve closing delay	0.5 ~ 2 seconds
Auto Shut-off	After 60 seconds
Sensing Distance	150mm (15cm) - adjustment possible by remote control (sold separately)
Warranty	5 Year replacement (refer to onvanti.com.au/warranty)
Maintenance & Care	Wipe down with a clean, soft dry cloth. If required use a mild/neutral detergent and water. Do not use cream cleaners or citrus based cleaning products, as they are abrasive. Use of unsuitable cleaning agents may damage the surface. Any damage caused in this way will not be covered by warranty.

